

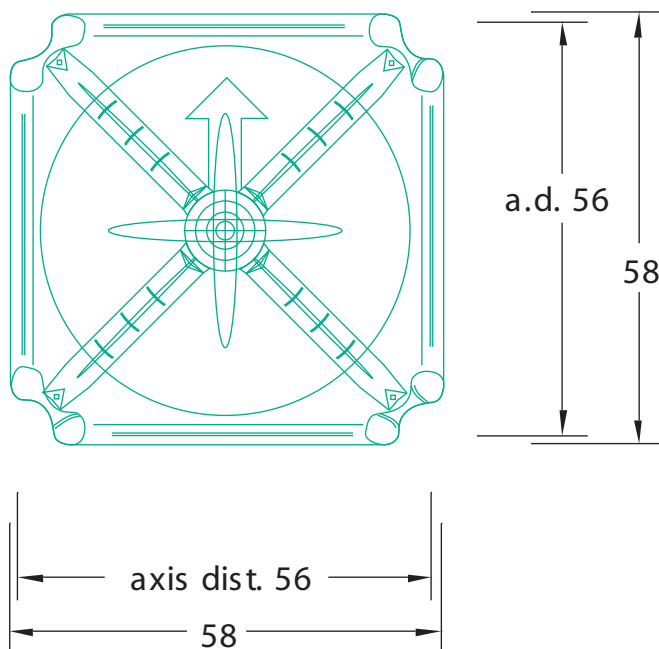

TECHNICAL INFORMATION ON CUPOLEX h. 40

RECYCLED POLYPROPYLENE UNIT TO BE USED FOR THE CREATION OF AERATED FLOOR. MODULE 56

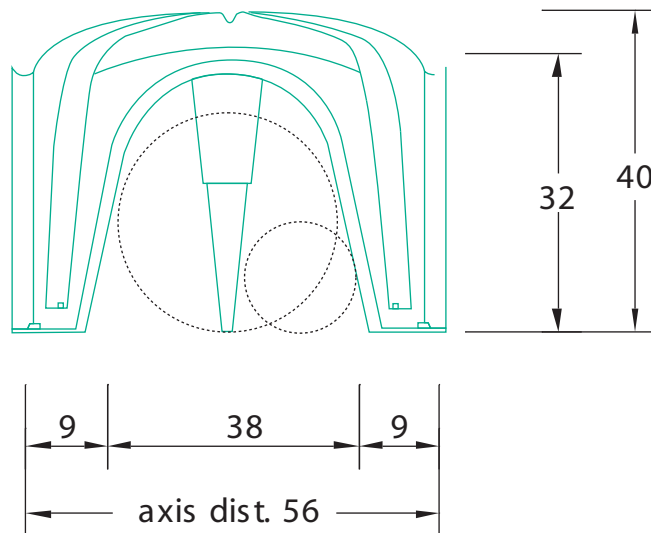

- Concrete consumption: $0,06 \text{ m}^3/\text{m}^2$
- Passing of pipes: n. 2 of 14 cm.
n. 1 of 25 cm (cutting the central cone)

ASSEMBLY:

EACH UNIT HAS INSTALLATION ARROWS. COMMENCE INSTALLATION BY STARTING FROM LEFT TO RIGHT IN HORIZONTAL ROWS, THEN GO CHECKING ON JOINTS ON FEET BASE.

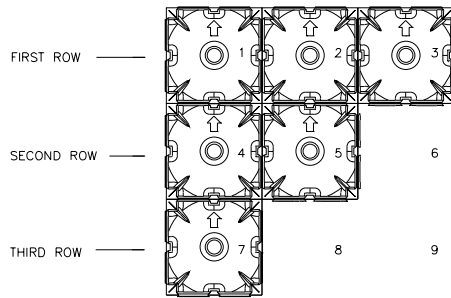

MAKE SURE THAT FEET ARE CORRECTLY INSERTED INTO THEIR SPECIAL JOINTS AND THAT PINS, WHWTHER USED, ARE INSERTED INTO THEIR PROPER HOLES

PACKING : ON WOODEN PALLETS WITH CELLOPHANE.

Pallet dimensions	n° of units	mq	Weight – kg/unit	Total weight
120 x 120 x h 200	320	100	1,5	500

DIRECTIONS:

- HANDLE WITH CARE. AVOID SHOCKS.
- PAY SPECIAL ATTENTION IN USING THE PRODUCT UNDER TEMPERATURE BELOW 0°C OR HIGHER THAN 35°C.
- CUPOLEX CAN BE TOTALLY RECYCLED.

LOAD CHART - DEAD LOAD (Kg/m²)

Concrete above Cupolex (cm)	Sub - base (cm)	Soil bearing capacity(Kg/cm ²)						
		0.8	1	1.2	1.5	2	2.5	3
3	Native soil	150	200	300	450	650	900	1000
3	10 Lean concrete	2000	2400	2600	2600	2600	2600	2600
3	10 Lean concrete 30 Compact grav.	2600	2600	2600	2600	2600	2600	2600
4	Native soil	-	170	275	430	600	900	100
4	10 Lean concrete	2000	2350	2600	2700	2800	2800	2800
4	10 Lean concrete 30 Compact grav.	2800	2800	2800	2800	2800	2800	2800
5	Native soil	-	150	250	400	600	850	950
5	10 Lean concrete	1950	2300	2550	2800	3000	3000	3000
5	10 Lean concrete 30 Compact grav.	3000	3000	3000	3000	3000	3000	3000
8	Native soil	-	-	150	350	550	800	900
8	10 Lean concrete	1900	2300	3200	4000	5100	5100	5100
8	10 Lean concrete 30 Compact grav.	5100	5100	5100	5100	5100	5100	5100
10	10 Lean concrete	2000	2400	3200	4000	4500	5500	5500
10	10 Lean concrete 30 Compact grav.	5100	5100	5100	5100	5100	6500	8000
12	10 Lean concrete	2050	2650	3200	4000	5100	6900	8350
12	10 Lean concrete 30 Compact grav.	5100	6800	7750	9750	10000	10000	10000

Load capacity

Building type	DEAD LOAD (Kg/m ²)	LIVE LOAD (Kg/m ²)	Slab Thickness above Cupolex (cm)	Wire Mesh
HOUSING	200	200	3	diam 5/25x25
PUBLIC BUILDINGS	200	300	4	diam 5/20x20
GARAGES	300	700	5	diam 6/20x20
INDUSTRIAL BUILDINGS	300	1200	6	diam 8/20x20